

SolexDWHX

Innovative System Technology
for Solar & Hydronics

- **Compact wall-hung design heat transfer station**
- **Integrated variable speed controller**
- **High-efficiency double wall heat exchanger**





Solar heat transfer station

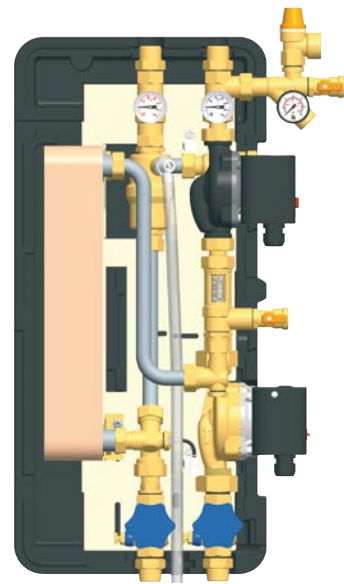

The solar heat transfer station Solex DWHX is a preinstalled and leak-tested unit with integrated double wall heat exchanger for transferring heat from the collector to the storage tank.

Completely insulated, with generously dimensioned double wall stainless steel plate heat exchanger, integrated preset and prewired controller assures a simple and quick installation as well as a safe commissioning.

It contains important fittings and safety devices for the operation of the solar thermal system:

- **Ball valves in supply and return in combination with check valves to prevent gravity and thermo circulation**
- **Connections for flushing, filling and draining the system**
- **Air vent for manual bleeding of the heat exchanger**
- **Flow meter for displaying and setting the flow rate**
- **Temperature gauges in supply and return for displaying both temperatures**
- **Pressure gauge for displaying the system pressure**
- **Pressure relief valve to prevent overpressure**
- **Three-speed solar pump for wide range of flow rates**
- **Three-speed bronze pump for the secondary (DHW) loop**

Compact wall hung design of the unit with insulation shell made of durable elastic EPP prevents heat losses and increases overall system efficiency. Integral to the unit are variable speed collector and storage tank circulators, double wall design heat exchanger, and the electronics to drive it all. With only four piping connections needed, the SolexDWHX significantly reduces the time and space required for installation.

The heat exchanger provides complete isolation between fluid on the collector side and domestic hot water.

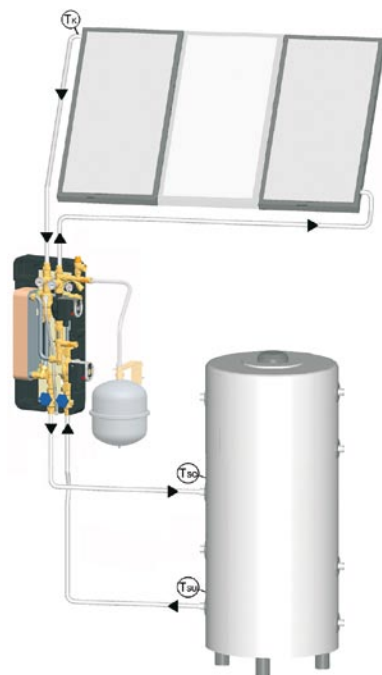

SolexDWHX - for systems up to 538 ft ² [0.4-0.74 G / (ft ² collector surface x h)]				
SolexDWHX 6094603US	Operating flow rate in solar loop		Performance	
	0.4 G/ft ² collector surface x h	15 l/m ² collector surface x h	85.3 MBH	25.0 kW
0.5 G/ft ² collector surface x h	20 l/m ² collector surface x h	64.2 MBH	18.8 kW	
0.6 G/ft ² collector surface x h	25 l/m ² collector surface x h	51.2 MBH	15.0 kW	
0.74 G/ft ² collector surface x h	30 l/m ² collector surface x h	42.7 MBH	12.5 kW	

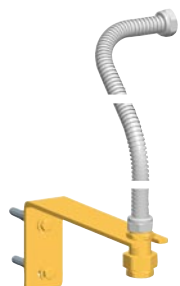
Item	SolexDWHX - 3/4" / DN 20	Item no.
	primary: Wilco Star-S21 ; secondary: Wilco Star-S21 BU	6094603US
Equipment		
	Connection set DN 20 for expansion tank for the connection of an expansion tank with a maximum tank diameter of 440 mm and max. 35 kg to the transfer station SolexDWHX	
	Stainless steel corrugated hose, wall bracket with mounting equipment, tank coupling with brass valves	437509

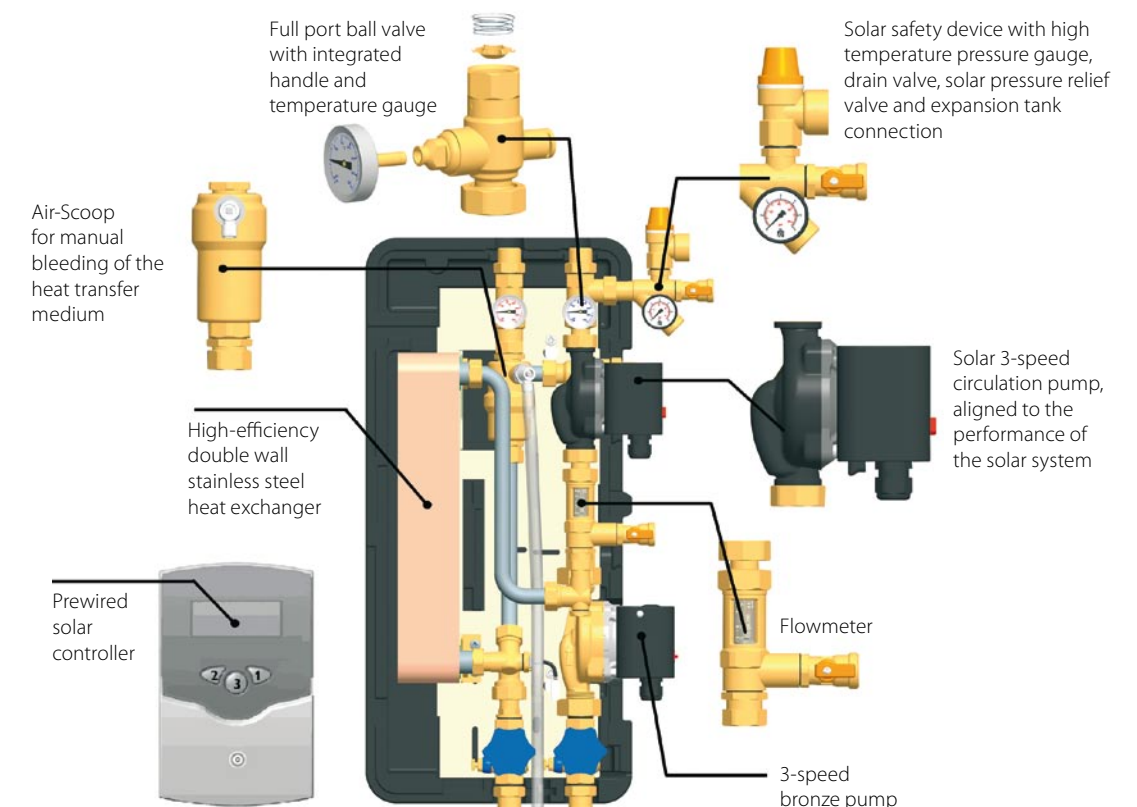

Technical data

SolexDWHX - 3/4" / DN 20

Materials	Fittings	Brass
	Gaskets	Klingersil / EPDM
	Insulation	EPP
	Check valve	Brass
	Heat exchanger	Plates + connecting pieces: 1.4400 Solder: 99.99 % copper
Technical data	Max. pressure	87 psi (6 bar)
	Max. temperature	248 °F, short-term 320 °F
Equipment	Check valves	7.87" wc primary 7.87" wc secondary
	Flowmeter	0.3 - 3.5 USgpm (1-13 l / min)
	Pressure relief valve	87 psi (6 bar), for solar thermal systems
	Manometer	0-87 psi (0-6 bar), resistant to high temperatures
	Thermometer	0-320 °F (0-160 °C) in the solar loop
	Controller	BS Plus
	Connections	primary loop: 3/4" cutting-ring connection secondary loop: 3/4" male thread
Dimensions	Overall width	15.6 in (390 mm)
	Overall height	25.6 in (650 mm)

Pressure drop SolexDWHX primary / pump characteristics

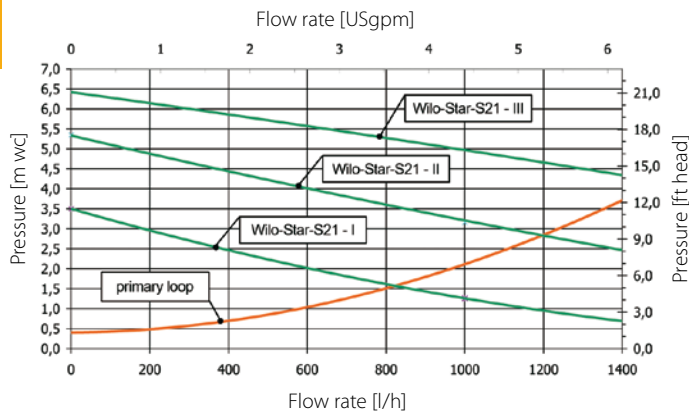

Pressure drop SolexDWHX secondary / pump characteristics

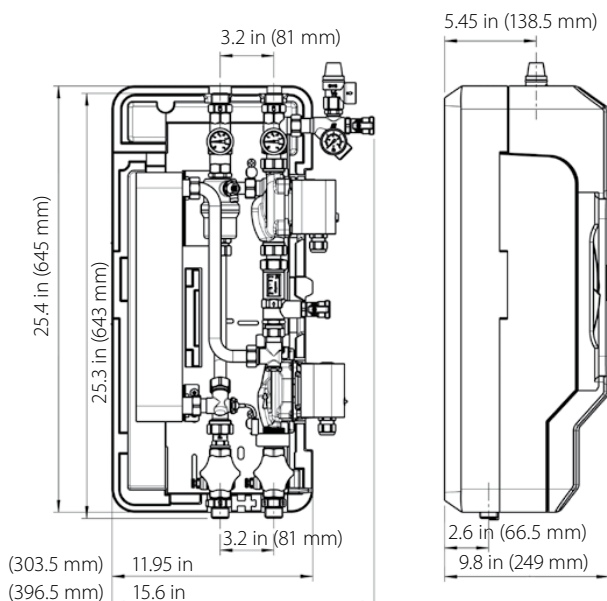
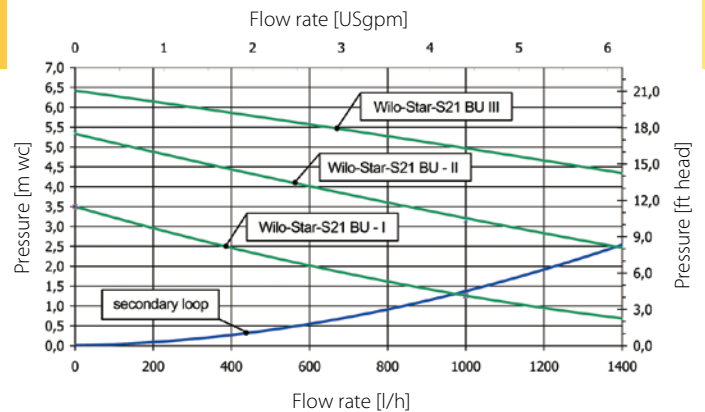

PAW LP.
45 Davis Street
Webster Ma. 01570
USA
@ support@paw.eu
www.paw.eu